

Impeller flow meter

JFS-S Instructions Manual

JFS-3S/10S/30S



Out line

This flow sensor Type JFS-S is used for measuring flow rate at high accuracy. Microprocessor processing technique make it possible to sense the measuring value very precisely. The result of measuring outputs to external terminal as analogue value and is shown as digital value on LCD. Further the result of displayed data compares the reference value to detect alarm signal, which output to "Open Collector" terminal and turns the LED on.

Before using our product.

- Please read carefully the instructions before you use our product.
- Please follow the procedures, conditions and cautions as per the instructions.

Safety information

Warning	Mishandling could cause injury or even death at drastic conditions.		Never do it.
Caution	Mishandling could cause disability, fire or other damages to the building or properties.		Do it only with following instructions.

Warning

Unusual or faulty conditions

- ❗ If you continue using our product under the unusual or faulty connections or conditions like as smoking, foul smell, unstable and malfunction, it could cause fire or accident. Cut the power supply immediately and contact to us. Do not try to repair the product yourself.

Working environments

⊗ In the humid or dewing environment, it could cause accident or damage because of moisture.

⊗ In the vibration, impulsion or pulsation environment, it could cause malfunction, some accident or damage.

⊗ Our products are NOT explosion-proof. Do not use in the dangerous environment with flammable, explosive, or corrosive gas.

⊗ Do not use outside. This product is only for inside.

⊗ Installation in high temperature environment as near to heat instruments could cause some accident or damage as the heat instrument will led the temp rise inside the flow meter. Please use our product as instructed in the manual.

Caution

Cables

⊗ Please do not put heavy objects on the cables or pull the cables from flow meter body, it could cause accident or damage.

❗ External device and cable or cable to each other, do not use come into contact with, you cause an accident or malfunction. Please use it after the insulation process one by one.

❗ Please follow the Instructions for "wiring", "Output signal", "how to put a load output", "Specifications" other wise, it could cause accident or damages.

Working environments

⊗ Magnetic power, electromagnetic wave, radioactive ray or ultraviolet rays could cause accident or damage.

⊗ Electric corrosion or static electricity could cause accident or damages.

⊗ In electrically noisy environments as like around high-frequency power source could cause accident or damages.

❗ Install the filter upper flow/inlet to clear some piece of metal or small objects if needed.

❗ Remove the bubbles in the fluid for accurate measurement of flow rate.

Packaging and carrying.

❗ Do not drop. Handle with care otherwise The flow meter could damage or cause malfunctioning.

Installations

❗ Mind your fingers while plumbing a sensor or you could get injured.

Others

⊗ Please contact us if you received damaged or deformed product.

Maintenance

⊗ Contact us for overhauling, adjusting or repairing. Please make sure not to touch an electronic substrate inside of flow meter.

❗ Only a person who has technical knowledge and experiences could do plumbing, wiring, maintenance or overhauling.

❗ While installation or maintenance please shut off the power and water supply for your safety.

Storage

• Please store our products under environments as follows.

- Where it is NOT exposed to rain or water.
- Where it is NOT exposed to direct sunshine.
- Where it is NOT exposed to dust.
- Where it is NO vibration or impact.
- Where it is static-free.
- Where ambient environment is controlled between 0-40 degree Celsius without dewing and freezing.
- Please store our products as you received.

Warranty and disclaimer

• We are not responsible regarding the accident that occurred from the incorrect use of our products or possible lack of information in this document.

• Warranty period of our product is one year from the received date of the product(s).

• If the claimed defect of specifications or materials in the period of the warranty are verified with a document, we will replace free of the product(s). This warranty covers only our products. This warranty does not cover direct or/and indirect damages like lost, damages or injurers etc. caused by defected products.

• We supply a replacement on request. And an inspection of the equipment does not disclose any defect causing by us, the replacement will be charged.

*The replacement is the same product as we sold but we would supply a different product for certain reasons.

*It refers the case which we do not have any responsibility.

In use out of non-compliance regarding this instruction manual.

Negligence in use.

Disassembling or conversion of our products.

About instructions manual

• It is not allowed to reprint or reproduce a part or full instruction manual without any prior permission by us.

• All the contents of instruction manual are correct at the date of publication and are subjected to change without notice. Please save the latest issue of our products.

• The contents of the outline and specification of the flow sensor in this operating manual has followed as per the standards. Care must be carried out properly while using sensor with a proper lay-out and consideration against external condition.

• Please contact us if you acknowledge any mistakes or unlisted information in this instruction manual.

*The design, dimensions and specifications of the product in the catalog were correct at the date of publication and are subjected to change without notice.

Configuration and Dimensions

The flow rate depends corresponding to the rotating impeller equipped with magnets which is perceived by the magnetic sensor. Flow rate is calculated and displayed by changing magnetism, at the same time output signals are output as a result.

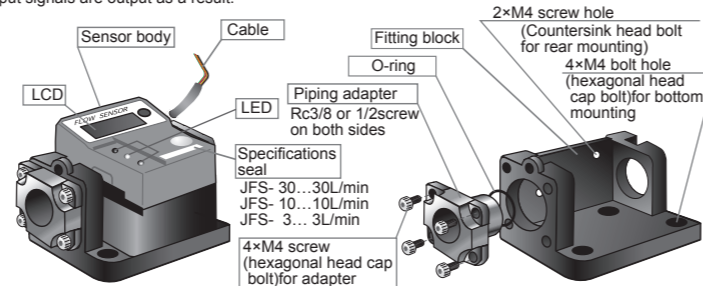

Fitting block can be fastened by means of either bottom fitting (by using 4 Nos. of M4 of hexagonal head cap bolt). For rear fitting (by using 2Nos. of M4 of a small countersinking screw) or by means of pipe construction depending on fitting way.

[Block size]

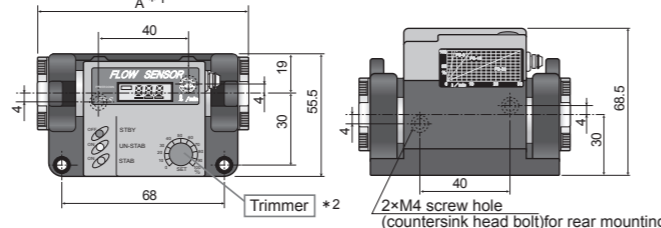

* 1 Dimension A differ depending upon the adapter type. Adapter connection size is determined by the selection at the time of the order.

[A Dimension Table]

Adapter connection size	BSBM	SUS
Rc3/8	92	98
Rc1/2	115	115

* 2 Please refer to the Operating method.

Specifications

Model	JFS-3S	JFS-10S	JFS-30S
Rated flow range	0.5 ~ 3.0L/min	1.5 ~ 10.0L/min	5.0 ~ 30.0L/min
Applicable fluid	Industrial water, Water		
Detection type	Impeller type		
Fluid temperature	0 ~ 60°C (No freezing, no dewing)		
Operating temperature	0 ~ 40°C (No freezing, no dewing)		
Accuracy *3	±2.5% F.S.		
Max. working pressure	1.0MPa		
Power supply voltage *4	DC12V±5% or DC24V±10%		
Current consumption	Voltage output Max. 20mA	Current output Max. 40mA	
Cable	AWM20276 (6cores 0.2mm ² 500mm)		
Flow Rate Display	2 digits LCD with every 0.1 Pitch	3 digits LCD with every 0.1 Pitch Constant scrolling LCD at 3 points	
Alarm output *5	Max. load current Less than DC100mA	Max. applied voltage Less than DC40V	
	Output mode A or B open collector output		
Alarm display	If alarm set value is regarded as A L/min.,		
	Lighting	• Green lighting : 1.2×A or more • Yellow lighting : (1 - 1.2) ×A • Red lighting : A or less	• Green lighting : 1.2×A or more • Yellow lighting : (1 - 1.2) ×A • Red lighting : A or less
		• Green lighting : 1.1×A or more • Yellow lighting : (1 - 1.1) ×A • Red lighting : A or less	
Power Down Display	1 blinking point LCD on power supply at 75% of the power supply.		
Analog output *6	Voltage output DC0 ~ 10V (over 3kΩload)	Current output DC4 ~ 20mA (under 300Ωload)	
Display	Numeric value LCD	Lighting LED	
Standard	RoHS compliance (Only SUS adapter)		
Wetted material	Polyacetal, Polyamide		
Connection material	SUS or BSBM (Ni plating)		
O-ring for sealing	Chloroprene or Fluoro rubber		
Orifice diameter	φ5	φ7	φ10
Adapter connection size	Rc3/8 or Rc1/2		
Weight	Approx. 380g		
Mounting position	Free		
Flow direction	Both direction		
Construction	Water drip-proof against electronic circuit		

* 3 Since F.S.(Full scale) is { 30L/min, 10L/min, 3 L/min } the deflection could be of { ±0.75L/min, ±0.25L/min, ±0.075L/min. }

* 4 Power supply is transmitted of either DC 12V or DC 24V at the time of the order.

* 5 Alarm output is set at the time of the order, 3S = 2.0L/min, 10S = 6.0L/min, and 30S = 20.0L/min.

* 6 Analog output is transmitted of either voltage or current output at the time of the order.

Flow Rate Characteristics

[Pressure Loss Diagram]

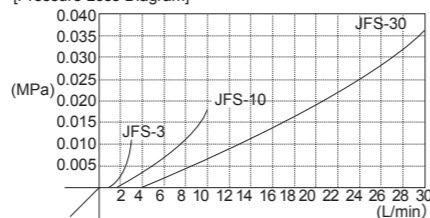

Following diagram shows pressure difference between primary and secondary pressure at 0.29MPa of original pressure.

Connections

[Fig.1]

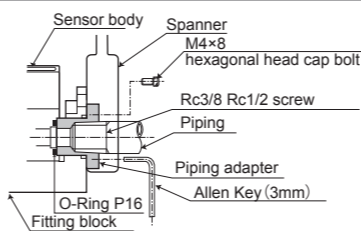

[Fig.2]

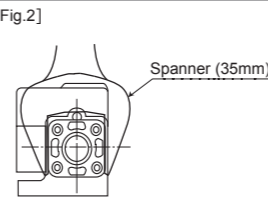

1. Piping connection must be done by means of screw into the piping adapter or by using KANTOUCH coupling.
2. Caution while fitting piping material
When applying a spanner (35mm) to fit the piping material, never fail to put it on the outer circumference of the piping adapter.

Caution Putting the spanner directly on the fitting block might cause a breakage of the flow sensor (see Fig.2).

3. Inner diameter of the piping adapter is Rc 3/8" or Rc1/2".
4. The piping adapter is fixed on the fitting block by using 4 Nos. of the hexagonal head cap bolt M4×8. Use a 3mm hexagonal screw driver or L-Type wrench for mounting and detaching the dapter.

Caution O-Ring (Type P-16) is inserted to the sealing surface between the Flow sensor body and Piping adaptor.

Do not forget to insert it and take care of twisting and strucking dust to it as it could affect the result in accuracy.

Warning

- (1) Fitting the sensor body without O-rings might cause leakage.
- (2) Please install the water filter in the pipe in case of handling impure water.
- (3) Do not use air while driving out the water from water pipes. It could lead the failure of flow sensor.

Wiring (Interface)

Connect the cable with the junction terminal and connector by means of soldering or crimping tool. It is recommended to use a cable with #24~#28 of the core size for connector.

[Cable functions]

Color	Name	Characteristic	Output selection	Operation and usage
Red	Power Supply(+)	DC12V±5% DC24V±10%	Alternatively	Connect +side of power supply. Supply +12V or +24V.
Black	Power Supply(-)			Connect -side of power supply. It is GND(0V). It is -line of analog output.
White	Analog output	0~10V 4~20mA	Alternatively	The flow rate is converted into an electric signal, which is sent to the equipment side. It is +line of analog output.
Yellow	Alarm output(A)	A output open collector		Alarm is reported to the equipment side. (A); Flow rate ≥ alarm value :ON
Brown	Alarm output(B)	B output open collector		Alarm is reported to the equipment side. (B); Flow rate < alarm value :ON
Green	Alarm output cable commonly used	Do not ground (COM)		Return of alarm output. Independent of the GND.

* 7 Analog display is transmitted of either voltage or current output at the time of the order.

* 8 Alarm output(A)=OFF output, Alarm output(B)=ON output.

Warning (1) Because it becomes the cause of accidents and failure external equipment and cables are in contact with each other or cable, do not use, please use it after the insulation process one by one.

(2) Voltage more than specified on the table will damage the product.

(3) Anti-polar connection might result destruction of the flow sensor.

(4) Analog output Alarm output It will destroy the output line is a short circuit in the power supply.

[How to bear load resistance]

Following diagram shows how the apparatus bear the load resistance generally.

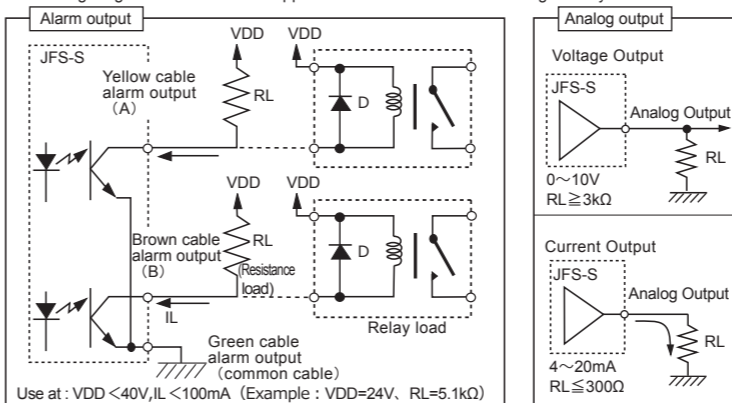

Caution

- When operating the unit under a relay load, use a diode built-in relay (D) to prevent breakdown of the transistor due to a counter-electromotive force.
- Analog display is transmitted on delivery of either voltage or current output.

Output signals

[Voltage output] (0~10V)

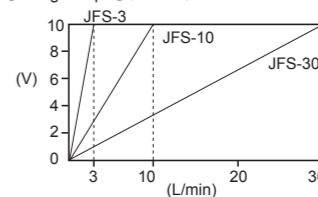

[Current output] (4~20mA)

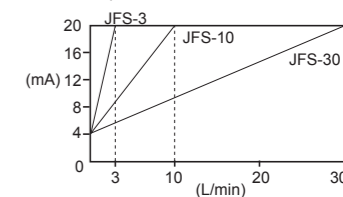

Operating method

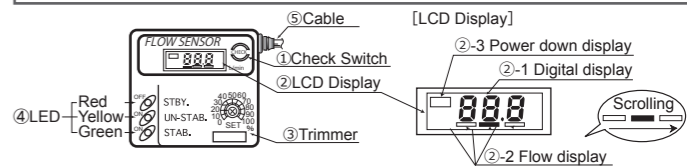

[Operation]

① Check Switch
This switch is used either for setting or checking the Flow rate. Pushing it once, the digital display of LCD start blinking and the alarm can be set by using ③ trimmer. Pushing it again flow rate comes back on the display.

② LCD Display
After inputting DC power supply the flow rate is displayed digitally on ②-1 and at the same time ②-2 starts scrolling from left to right showing the existence of flow rate. It doesn't related on the flow rate and continues scrolling constantly. (If there is no flow then no scroll will be appeared.)
Flow rate is displayed as follow and when overflow occurs, indication of UP will be displayed. [UP]: Flow rate exceeds the specification flow range.

JFS-3S : 0.0 ~ 3.0 L/min
JFS-10S : 0.0 ~ 10.0 L/min
JFS-30S : 0.0 ~ 30.0 L/min } with a pitch of 0.1 L/min

②-3 Power Down Display
When DC power voltage gets lower (under 18V for DC 24V specification and under 9V for DC12V specification), ②-3 will start blinking. DC power voltage should be within following range.
(In case of 24V specification : DC24V± within 10%
(In case of 12V specification : DC12V± within 5%

③ Trimmer
• Trimmer scale
Trimmer scale is used for setting alarm with 0~100% scales with every 10% adjustment. Approximate relation between Flow rate (L/min.) and ③ Trimmer figures (%) are shown in following graph as well as the label pasted at the side of the sensor case. Refer below the graphs and set up the desired flow rate as per the requirement.

• Alarm Setting Method
After inputting DC power supply, the flow rate is displayed digitally on ②-1 and at the same time ②-2 starts scrolling from left to right showing the existence of flow rate. It doesn't related on the flow rate and continues scrolling constantly. (If there is no flow then no scroll will be appeared.)

④ LED Display
LED STBY. (=Stand by)
Shows an insufficient flow rate condition.

Yellow UN-STAB. (=unstability)
Shows an critical condition of flow rate.

Green STAB. (=Stability)
Shows moderate flow rate condition.

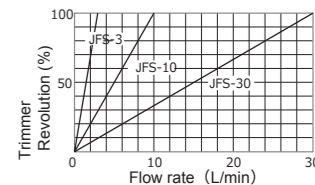

The definitions of the alarm output and display LED are specified in <Table 1>.

For the alarm output, ON indicates conductive and OFF indicates non-conductive in open-collector.

Measurement value	Alarm	A	B
JFS-3S JFS-10S JFS-30S	above 1.2 times of A	Green lamp is ON	Green lamp is ON
JFS-3S JFS-10S JFS-30S	above 1.1 times of A	ON	OFF
JFS-3S JFS-10S JFS-30S	1~1.2 times of A	Yellow lamp is ON	Yellow lamp is ON
JFS-3S JFS-10S JFS-30S	1~1.1 times of A	ON	OFF
JFS-3S JFS-10S JFS-30S	less than A	Red lamp is ON	Red lamp is ON

⑤ Cable
This is a 6 cores cable consisting of 2 cores for DC power supply to the flow sensor itself and 4 cores for sensor output, while a common earth wire is used for power source and analog output.

Maintenance

[Removing Sensor Body]

- (1) Turn the power supply OFF (Power supply cable must be taken out, because this flow sensor is not provided with power supply switch).
- (2) Loosen 4 Nos. of M4 screws for the adapter (hexagonal socket head cap bolt M4×8) by using an Allen key. (see following figure)
- (3) Slide the Flow sensor body slightly towards the loosened adapter as directed above. (2)
- (4) Some space appears between the adapter and flow sensor body. Sliding the sensor body towards flowing direction, the sensor body can be pulled out towards the upward direction of the block or towards the side. At that time, care must be taken that fluid inside piping might run over.
- (5) Installation can be done in reverse side of the flow sensor.

Caution Be careful that O-rings on both sides do not fall down.

* Please contact us if you have any questions or concerns of maintenance on. If the failure dismantling of the product, due to the decomposition is found, I will not be responsible.